

# JBC

www.jbctools.com

English



## 1 Tool Control Unit

Ref. DI-D

## Packing List

The following items should be included:

**DI Control Unit** ..... 1 unit  
Ref. DI-1D (120V)  
DI-2D (230V)  
DI-9D (100V)



**Power Cord** ..... 1 unit  
Ref. 0009417 (100V/120V)  
0009401 (230V)



**Manual** ..... 1 unit  
Ref. 0014650



## Features

For a basic working system, you need 1 control unit, 1 stand, 1 tool and 1 cartridge.

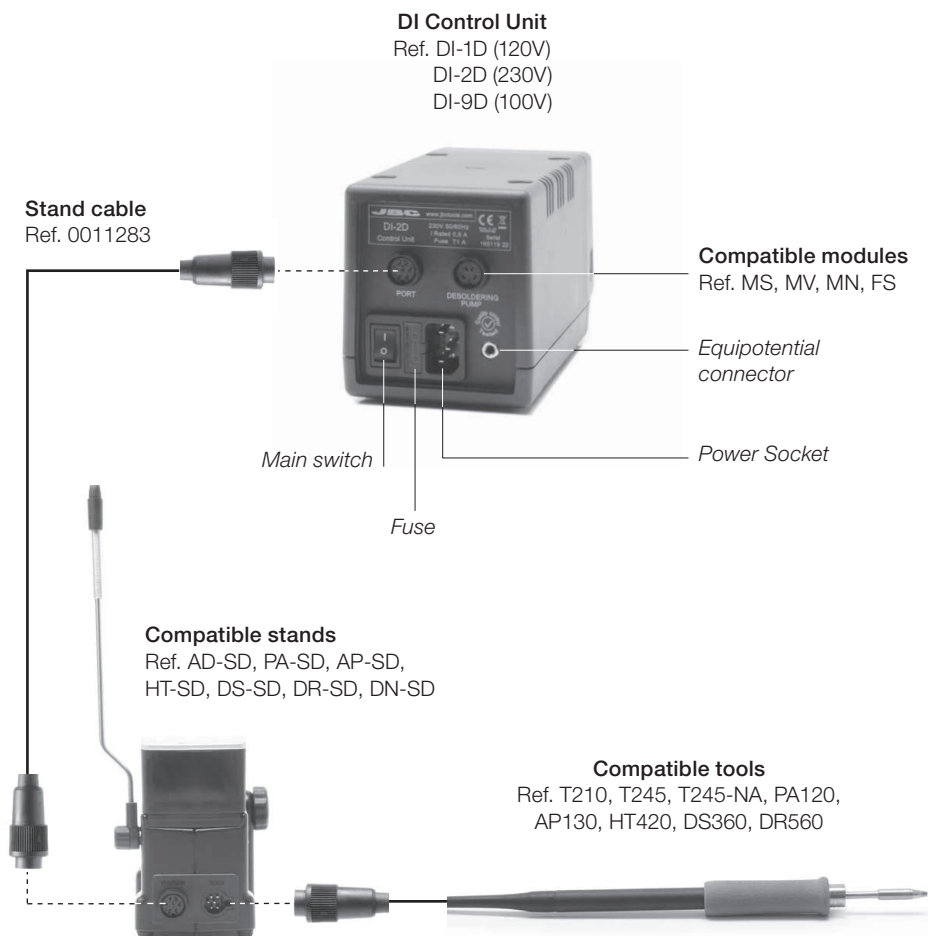

## USB Connector

Download the latest software from our website to improve your soldering station.

### JBC Updater

[www.jbctools.com/software.html](http://www.jbctools.com/software.html)

Update the station software via USB connection:

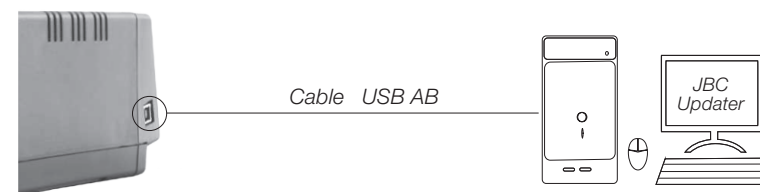

### JBC Manager

[www.jbctools.com/manager.html](http://www.jbctools.com/manager.html)

Manage and monitor as many stations as your PC can handle by using the JBC Manager. You can export data to another PC.

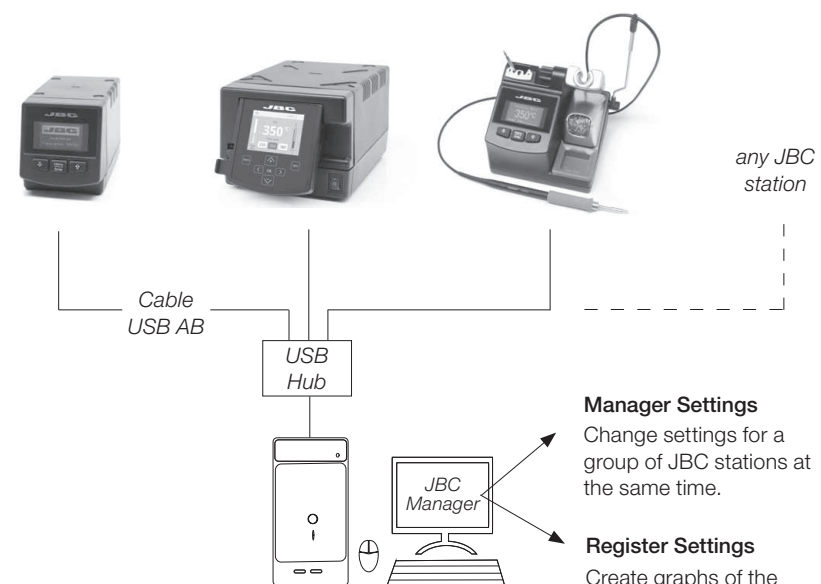

## Operation

### The JBC Exclusive Heating System

Our revolutionary technology is able to recover tip temperature extremely quickly. It means the user can work at a lower temperature and improve the quality of soldering. The tip temperature is further reduced thanks to the Sleep and Hibernation modes which increase the tip life by 5.

#### 1. Work



When the tool is lifted from the stand the tip will heat up to the selected temperature.

#### 2. Sleep



When the tool is in the stand, the temperature reduces to 180°C / 360°F (preset sleep temperature).

#### 3. Hibernation



After longer periods of inactivity (pre-set to 30 min.), the power is cut and the tool cools down to room temperature.

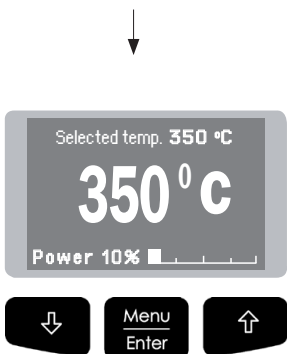

- Change temperature (from 90 to 450°C)
- Select temperature levels
- Fix one temperature



- Change Sleep temperature
- Set Sleep delay (from 0 to 9 min or no Sleep)



- Set Hibernation delay (from 0 to 60 min or no hibernation)

## Process Control

### Work Screen

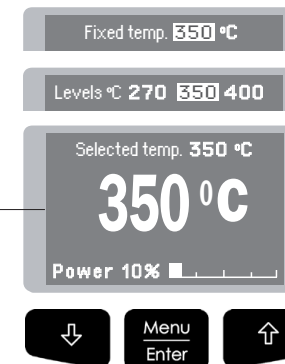

Displays a specific fixed temp.

Shown once you have selected temp. levels.

The work screen provides useful information of tool status in real time.

### Menu Screen

Original PIN: 0105

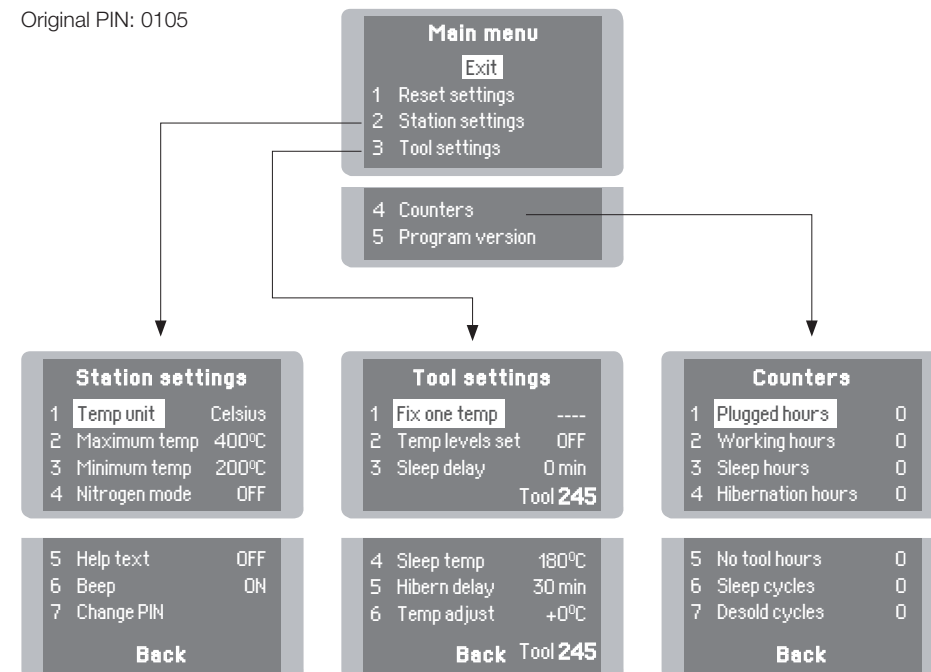

## Maintenance

Before carrying out maintenance or storage, always allow the equipment to cool and unplug the stand from the station and the tool.

- Clean the station screen with a glass cleaner or a damp cloth.
- Use a damp cloth to clean the casing, the stand and the tool. Alcohol can only be used for cleaning the metal parts.
- Periodically check that the metal parts of the tool and stand are clean so that the station can detect when the tool is in the stand.
- Maintain tip surface clean and tinned prior to storage in order to avoid tip oxidation. Rusty and dirty surfaces reduce heat transfer to the solder joint.
- Periodically check all cable connections.
- Replace a blown fuse as follows:

Clean periodically

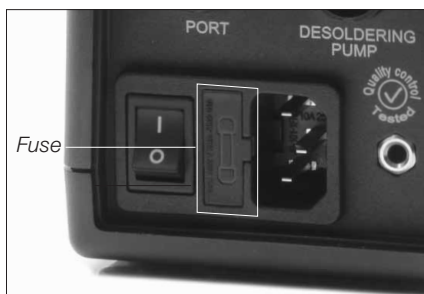

**1.** Remove the fuse by pulling the black cap. If necessary use a tool to lever it off.

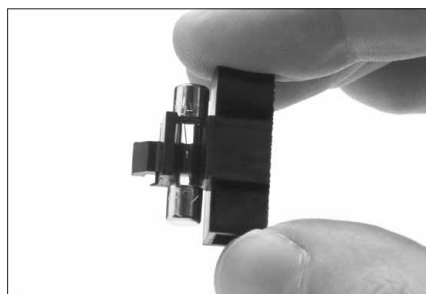

**2.** Press the new fuse into the holder and replace it in the station.

- Replace any defective or damaged pieces. Use original JBC spare parts only.
- Repairs should only be performed by a JBC authorized technical service.

## Safety



**It is imperative to follow safety guidelines to prevent electric shock, injury, fire or explosion.**

- Do not use the equipment for any purpose other than soldering or rework. Incorrect use may cause fire.
- The power cord must be plugged into approved bases. Be sure that it is properly grounded before use. When unplugging it, hold the plug, not the wire.
- Do not work on electrically live parts.
- The tool should be placed in the stand when not in use in order to activate the sleep mode. The soldering tip, the metal part of the tool and the stand may still be hot even when the station is turned off. Handle with care, including when adjusting the stand position.
- Do not leave the appliance unattended when it is on.
- Do not cover the ventilation grills.
- Heat can cause inflammable products to ignite.
- Use a "non residue" classified flux and avoid contact with skin or eyes to prevent irritation.
- Be careful with the fumes produced when soldering.
- Keep your workplace clean and tidy. Wear appropriate protection glasses and gloves when working to avoid personal harm.
- Utmost care must be taken with liquid tin waste which can cause burns.
- This appliance can be used by children over the age of eight and also persons with reduced physical, sensory or mental capabilities or lack of experience provided that they have been given adequate supervision or instruction concerning use of the appliance and understand the hazards involved. Children must not play with the appliance.
- Maintenance shall not be carried out by children unless supervised.

## Exploded View

SPARE PARTS	
<b>DI-1D / DI-2D / DI-9D:</b>	
-CIRCUIT	0013287
-ENCLOSURE	
· TOP	0011435
· BOTTOM	0007544
· FRONT	0013830
· BACK	0003506

DI-1D 120V FUSE T-2A  
 DI-2D 230V FUSE T-1A  
 DI-9D 100V FUSE T-2.5A

DI-1D / DI-2D / DI-9D

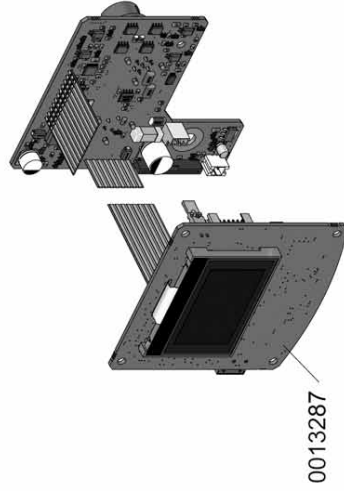

0013287

**DI-1D** 120V  
**DI-2D** 230V  
**DI-9D** 100V  
 1 TOOL CONTROL UNIT

## Specifications

- DI-1D** 120V 50/60Hz. Input fuse: 2A. Output: 23.5V.
- DI-2D** 230V 50/60Hz. Input fuse: 1A. Output: 23.5V.
- DI-9D** 100V 50/60Hz. Input fuse: 2.5A. Output: 23.5V.
- Weight: 2.2 kg (9.6 lb)
- Dimensions: 90 x 105 x 180 mm
- Temperature Range: from 90°C (190°F) to 450°C (840°F)
- Idle Temp. Stability (still air): ±1.5 °C / ±3 °F
- Output Peak Power: 130W
- Tip to ground resistance: <2 ohms
- Tip to ground voltage: <2mV RMS
- Ambient operating temp: 10-40 °C / 50-104 °F
- USB connector station-PC

Complies with CE standards  
 ESD protected housing "skin effect"

# JBC

---

## Warranty

JBC's 2 year warranty covers this equipment against all manufacturing defects, including the replacement of defective parts and labour.

Warranty does not cover product wear due to use or mis-use.

In order for the warranty to be valid, equipment must be returned, postage paid, to the dealer where it was purchased.

---



This product should not be thrown in the garbage.

In accordance with the European directive 2002/96/EC, electronic equipment at the end of their life must be collected and returned to an authorized recycling facility.